



POOL LIFT METALU 3800

BATTERY-POWERED POOL LIFT



METALU WARRANTY

3 YEARS The lift

5 YEARS All spare parts

MANUAL AND CERTIFICATES



Table of contents

Lift manual and certificates	3
1. Manufacturer details.....	3
2. Functional characteristics.....	3
3. Main product standards.....	5
4. EC Declaration of conformity	6
5. Identification plate	7
6. Warranty certificate	7
7. Commissioning certificate	8
8. Installation certificate.....	9
9. Standard package components	10
10. Shipping components.....	11
11. Spatial dimensions of the lift.....	12
12. Proper use of the product and maintenance.....	14

Lift manual and certificates

1. Manufacturer details

Company name: Manufacturas Metálicas Luisianeras. S.L.

Address: Polígono industrial Los Motillos, C/ Madrid No. 11, units A, C, D, G, H. 41430.

City: La Luisiana (Sevilla) – España.

Tax ID: B – 41.834.508

Main telephone: +34 955 907 784

Website: www.ascensoracuatico.com

Email: info@ascensoracuatico.com

2. Functional characteristics

The METALU S-3800 Pool Lift is designed to enable access to swimming pools for people with reduced mobility, either in an **assisted** way (S-3800) or **autonomously** (S-3800/1). It is battery-powered and does not require a connection to the mains. The design is customised for each pool profile. This lift is only suitable for raised pools with a wall height of up to 1500 mm. It is installed on the ground and fixed using anchoring plates and internally threaded sleeves $\text{Ø}12 \times 90$ mm with epoxy fixing resin to the ground and the outer wall of the pool. Optionally, it can be equipped with a double wall anchoring system to avoid drilling into the ground. It is made of **AISI 316 stainless steel** with powder coating protection and has a load **capacity of up to 120 kg**. The rotation range is **360° in both directions** (the rotation range can be limited), with movement speeds **below 0.1 metres** per second; therefore, acceleration and deceleration ramps are not significant. **The vertical movement of the seat** depends on the pool profile, with a maximum limit of 1.60 m. **Different arm options and seat positioning** are available to adapt to the pool profile.

It is necessary to **complete the pool profile form** provided by the METALU customer service office in order to design the lift and analyse the compatibility of the product with the pool profile.



Among the main characteristics of this product, the following points should be highlighted:

- **It operates with a battery**, without the need for a connection to the electrical mains
- Lift design **fully customised** for each customer.
- The movement of the aquatic lift is carried out in three phases:
 1. **Raising** the user.
 2. **Rotation** until the user is positioned above the water.
 3. **Lowering** until the desired immersion level is reached.
- **Standard rotation range of 360°** in both directions (can be limited).
- **Fully autonomous** user in the autonomous S-3800/1 model.
- **Removable seat** to prevent improper use.
- Adaptability:
 - **Different arm lengths** to adjust to the required reach.
 - **Seat positioning** (right, left or front) according to needs.
 - Possibility of **limiting the rotation** range of the lift.

The technical characteristics of the METALU S-3800 model are shown below.

Technical characteristics S-3800		
Material	AISI 316 stainless steel	-
Maximum load capacity	120	kilograms
Rotation range*	360° (can be limited)	degrees
Net weight* (approximate)	90	kilograms
Packed weight* (approximate)	176	kilograms
Movement speeds	Below 0.1 m/s	m/s
Vertical seat travel*	Depends on the pool profile (maximum 1.60 m)	metres
Raising time without load*	44	seconds
Raising time with 85 kg load* (approximate)	51	seconds
Lowering time without load* (approximate)	42	seconds
Lowering time with 85 kg load* (approximate)	42	seconds

* Information dependent on the pool profile.

3. Main product standards

- The manufacture and finishing of the lift comply with the following characteristics:
 - The entire structure and accessories are manufactured in **AISI 316 stainless steel**.
 - All metal finishes avoid edges that could **cause injury**.
 - All fasteners used pose **no risk**, as everything is assembled with round-head screws to prevent scratching or snagging the user.
 - In the moving parts, sufficient clearances have been left to avoid any risk of **trapping limbs**.
- A standard warning sign indicating the **maximum load capacity** (120 kg) is included.
- The static coefficient has been taken into account and doubled for the calculation of **mechanical strength and tipping risk**.
- The speed of movement of the moving parts is smooth, **below 0.1 m/s**, avoiding the risk of falling from the seat.
- The lift is equipped with a red **emergency stop** located on the control box in a visible and accessible place.
- The battery, the control box and the control unit include a battery charge indicator.
- The linear actuator for raising/lowering the lift includes a red **emergency nut** that allows manual lowering if necessary.
- The operating control unit includes a **locking key** to disable the entire electrical system.

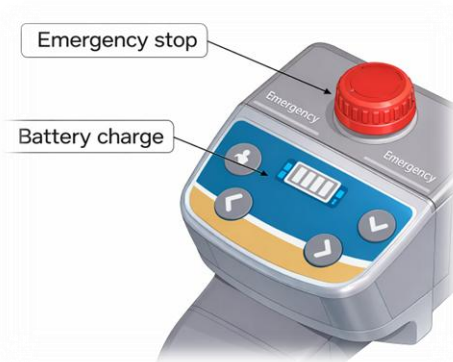
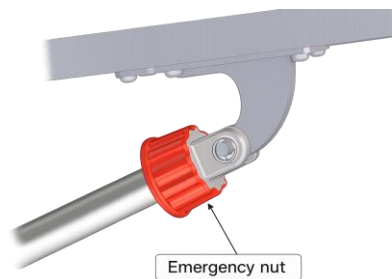

4. EC Declaration of conformity



EC DECLARATION OF CONFORMITY

The undersigned, on behalf of the company:

- **Company name:** Manufacturas Metálicas Luisianeras. S.L
- **Tax ID:** B - 41.834.508
- **Address:** Polígono industrial Los Motillos, C/ Madrid No.11, units A, C, D, G, H. 41430.
- **City:** La Luisiana (Sevilla) – España.

Product description:

- **Model:** METALU S-3800 y METALU S-3800/1
- **Type:** Pool lift with electric lifting movements (24 V) to facilitate access to and exit from swimming pools for people with reduced mobility.
- **Capacity:** Lifting capacity 120 kg or 150 kg.

Provisions with which the machine complies

The machine complies with the provisions set out in Directive 2006/42/EC of the European Parliament and of the Council of 17 May 2006 on machinery.

Harmonised standards and technical specifications applied

- **UNE-EN 61310-1:2008.** Safety of machinery. Indication, marking and actuation.
Part 1: Requirements for visual, acoustic and tactile signals.
- **UNE-EN 61310-2:2008.** Safety of machinery. Indication, marking and actuation.
Part 2: Requirements for marking.
- **UNE-EN ISO 12100:2012.** Safety of machinery. General principles for design.
Risk assessment and risk reduction
- **UNE-EN 547-3:1997+A1:2008.** Safety of machinery. Human body measurements.
Part 3: Anthropometric data.

La Luisiana, 14 november 2014

A handwritten signature in blue ink, appearing to be 'M. Escalera Soler', written in a cursive style.

Fdo. D. Manuel Escalera Soler.
Managing director.

7. Commissioning certificate

Main details of the manufacturing company:

- **Company name:** Manufacturas Metálicas Luisianeras, S.L.
- **Tax ID:** B – 41834508.
- **Address:** Polígono Industrial Los Motillos, C/ No. 11, units A, C, D, G, H. 41430.
- **City:** La Luisiana (Sevilla) – España.

Product description:

- **Model:** METALU S-3800 - S-3800/1.
- **Type:** Battery-powered aquatic lift with electric lifting movements to facilitate access to and exit from swimming pools for people with reduced mobility.
- **Capacity:** Lifting capacity 120 kg.

Technical Construction File endorsed by the Association of Technical Engineers and Surveyors of Seville.

This document certifies that:

1. The competent technician (Jesús León Delis, registration No. 10061) certifies **the assembly, commissioning and putting into service of the product described above.**
2. The manufacture and assembly of the lift have been carried out in accordance with the technical project and its assembly drawings.
3. The design and manufacture have been carried out in accordance with current Spanish regulations relating to machinery safety, taking into account the following harmonised standards: UNE-EN 61310-1-2008, UNE-EN 61310-2-2008, UNE-EN ISO 12100-2012, UNE-EN 547-3-1997+A1:2008.
4. The pool lift bears the CE marking, and therefore its manufacture and design comply with the regulations of the European Economic Community.

La Luisiana, 4 November 2014.

The competent technician:



Jesús León Delis

Registration No. 10061

The manufacturing company:



Manuel Escalera Soler

8. Installation certificate

Installation company:

Declares: that the lift has been installed in accordance with the instructions provided by the manufacturer.

Product: Pool lift "METALU S-3800":

Manual assistant "METALU S-3800"

Autonomous assistant "METALU S-3800/1"

Serial No.:

Installation date:

Place of installation:

Installer's name:

Installer's ID No.:

Installer's signature:

9. Standard package components

The standard package of the METALU S-3800 and METALU S-3800/1 models consists of the following components:

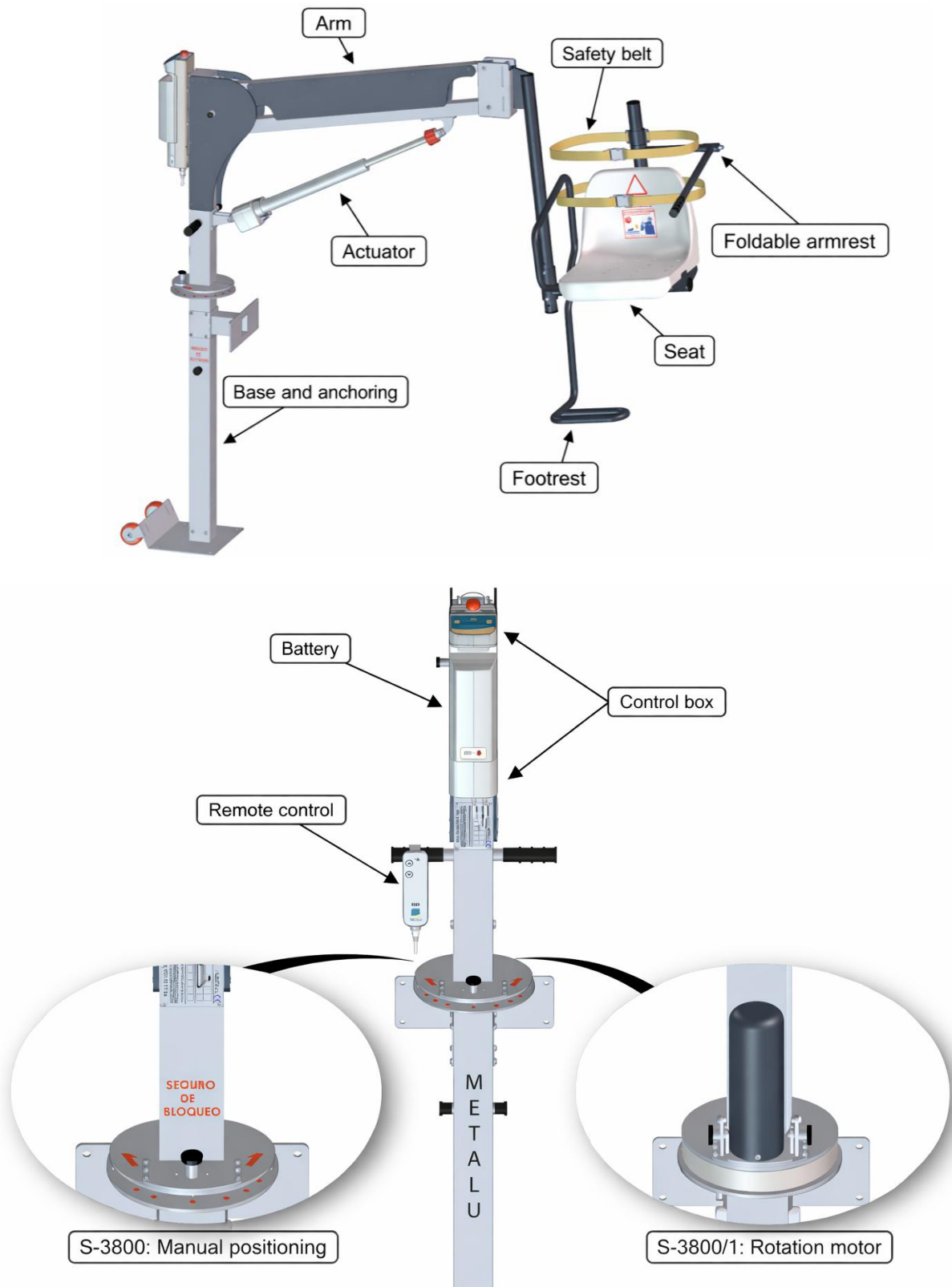

10. Shipping components

Shipping components for the standard order			
Order type	Equipment weight [kg]	Dimensions (width, length) [mm]	Contents
Standard order	176	Euro pallet: 1200 x 800 Height depending on lift design.	1. Anchor, mast and electronic components
			2. Lift base
			3. Seat
			4. Arm.
			5. Documentation: <ul style="list-style-type: none"> • Manual and certificates. • Installation and assembly.
			6. Auxiliary battery
			7. Battery charger
			8. Anchor bolts (8 units)

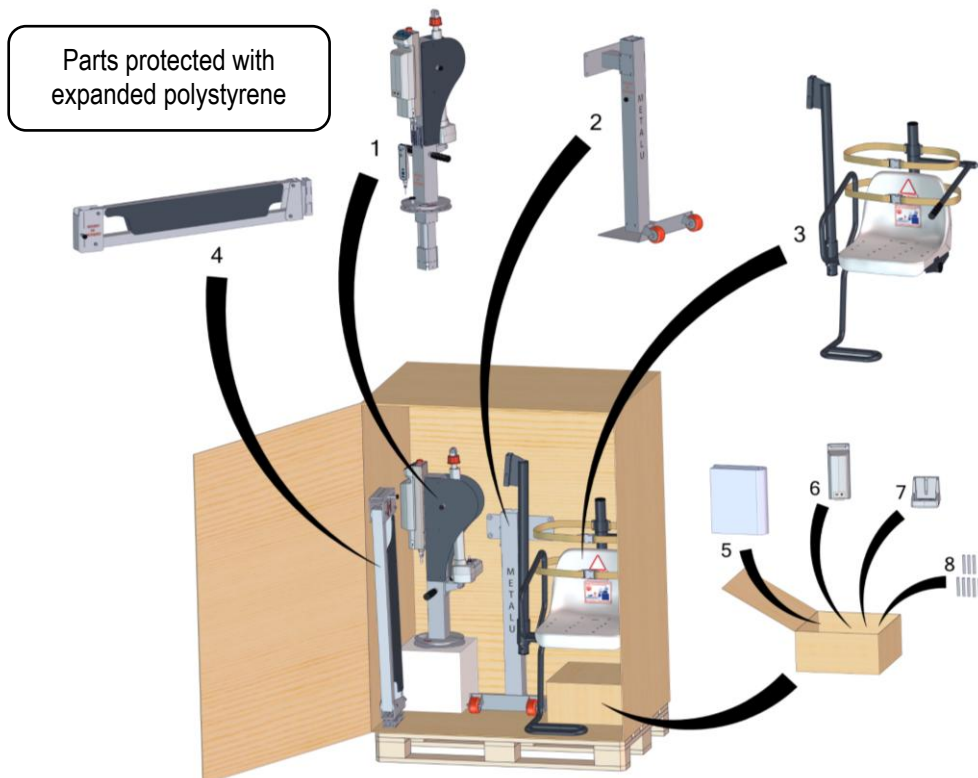

11. Spatial dimensions of the lift

The METALU S-3800 and S-3800/1 models are manufactured with a customised design according to the pool profile required by the lift. Therefore, the dimensions of the lift arm and the seat tube may vary.

The following image shows the dimensions of the lift for a standard model (974 arm), units in millimetres [mm].

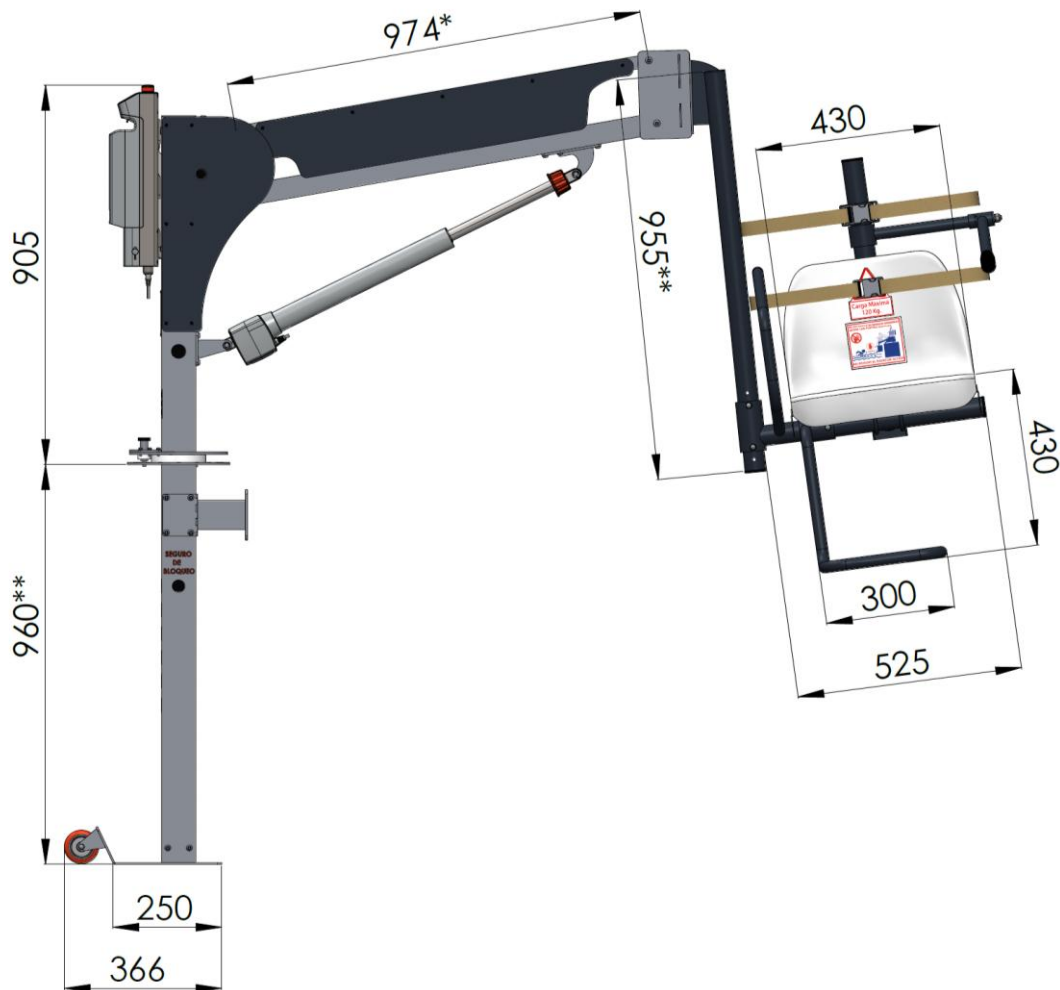

* Arms of different sizes are available to adapt to any type of pool. For more information regarding other lift arms, refer to the document "Adaptability to the pool basin" for the METALU S-3800 model.

** The dimension of the seat tube is adjusted to a larger or smaller size to adapt to any type of pool.

The lift must be installed away from obstacles within its operating area. In three-dimensional space, the operating area of a standard lift is shown in the following image:

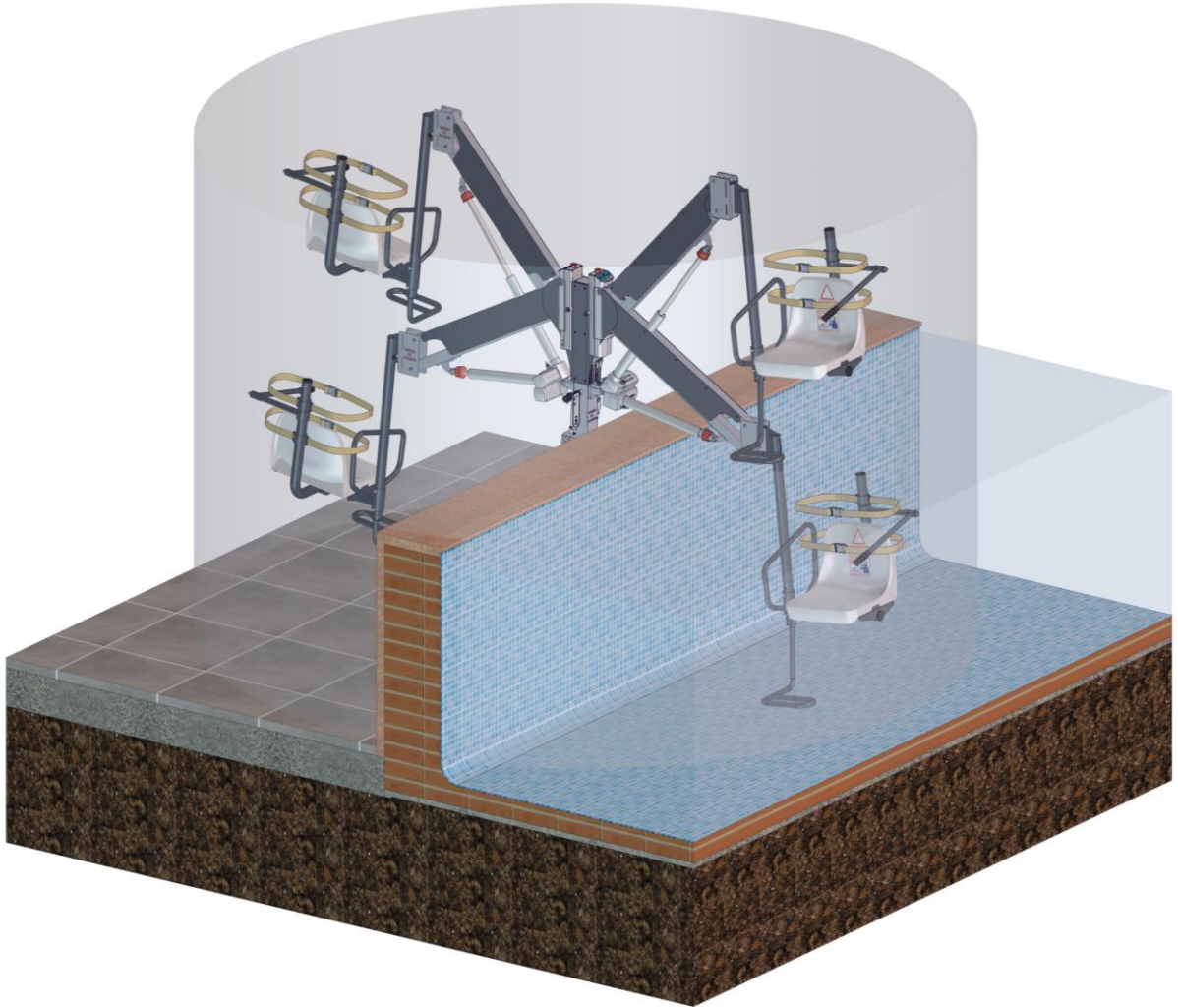

Working area of the lift in three-dimensional space for a standard lift.

12. Proper use of the product and maintenance

- Preliminary considerations.
 - For correct use and safe operation of the pool lift, follow all the instructions in this manual and comply with the precautions and warnings provided, as well as the maintenance instructions. It is the responsibility of the lift owner to ensure that the instructions in this manual are carried out.
 - If some users require assistance from third parties, the number of assistants required for transfer to the seat and for immersion in the water must be taken into account. In any case, for the manual rotation model, at least one assistant will always be required to operate the rotation of the Pool Lift.
 - If the Pool Lift is to be used autonomously by a person with reduced mobility, without assistance, a communication device must be available in the area of use to request help if necessary.
 - While movement is taking place or about to begin, all parts of the body of both users and assistants must be kept away from the moving parts.

- User position on the Pool Lift.
 - The user position is the seat, from which the control unit (push-button panel) is easily accessible.
 - The S-3800/1 model (autonomous user) has a safety attachment located next to the seat. This attachment ensures that the control unit (push-button panel) is always within reach of the user.
 - During movement, the user's limbs do not come into contact with the lift parts or the pool edge, provided that their arms are on the armrests and their feet are on the footrest.

- Proper use of the lift:
 - Use the lift responsibly, understanding its functionality and purpose before use.
 - The lift must not be used unless the proper steps for commissioning have been followed. Check the assembly and installation described in the manual.
 - The lift must only be used by persons authorised by the facility.
 - Before using the lift, the user must ensure that no person or obstacle is within the path of the lift's moving parts.
 - Once the user is in the pool, the seat must be returned to its initial position, thus preventing the lift from becoming an obstacle for other users.
 - The load capacity of the lift, and therefore of the user, is 120 kg.
 - It is prohibited for more than one person to use the lift at the same time, even if the combined weight is less than 120 kg.
 - It is prohibited to use the lift as a platform for play, jumping, etc.
 - The seat complies with anthropometric measurements according to the European standard.
 - Follow the visual indications provided by the product.
 - Do not immerse the control unit (push-button panel). It may be exposed to splashes and water jets (IP66).

- Maintenance:
 - Rinse the structure with fresh water, taking special care not to direct the water flow towards the 24V electrical components, then dry completely with a cotton cloth.
 - The installation area of the lift must have suitable environmental conditions to prevent stains on the Pool Lift:
 - Properly regulate ambient **humidity levels**.
 - Properly regulate **the ventilation system**.
 - Properly regulate **water parameters**, keeping them balanced within recommended levels: pH, chlorine and/or salt (including during winter periods).
 - Dry the 24V electrical components from any splashes.
 - Check the battery charge level and recharge if necessary; charge the batteries before they are fully depleted (approx. 20 cycles).
 - Check that all plugs are correctly connected in the control box.
 - Check the correct operation of the lift.
 - Periodically, visually check that all parts of the lift are in good condition and that all bolts and nuts are properly tightened. If any part is damaged, do not use the lift until it has been replaced. Increase the frequency of these inspections in indoor pools.
 - Regularly clean the metal connections of the battery, charger and control box using a nylon scouring pad.
 - At the beginning of the season, apply lithium grease to the gears of the S-3800/1 model.
 - If the lift is not used for several weeks, it is recommended to operate it with a medium load (approx. 75 kg), performing several lifting and lowering cycles. This will help maintain the components in good condition.
 - During periods of non-use, store the lift in a covered place with suitable environmental conditions to prevent stains:
 - Properly regulate room **humidity levels**.
 - Properly regulate the room **ventilation system**.
 - Properly regulate room **temperature**.
 - Avoid placing the lift near **chemical/toxic products**.
 - During low season or periods of little use, charge the batteries at least once a month, even if they are not being used.

INDOOR POOLS: maintenance, and especially cleaning, must be much more rigorous due to atmospheric conditions, temperatures and the environment generated. For more information about maintenance, visit the following link.

For more information about maintenance, visit the following link.



Correct use of the METALU S-3800 Pool Lift with manual rotation:

The process begins with the user entering the pool:

1. Access to the seat can be made from whichever side is most convenient and easiest for the user.
2. Release the emergency stop on the control box.
3. Before sitting down, ensure that rotation is locked. There is a positioning device that performs the rotation locking function.
4. Sit on the seat, place your feet on the footrest and fasten the safety belt.
5. The assistant will unlock the rotation and take the control unit (push-button panel). This control operates the lifting and lowering actuator.
6. From the lowest position (to pick up the user), start lifting until the footrest clears the height of the pool edge.
7. The assistant, coordinated with the user, will rotate the lift until it is positioned over the pool water surface.

IMPORTANT: it must be verified that there are no swimmers in the water who could be under the seat of the Pool Lift at any point during its movement. The landing area must be monitored to prevent accidental impact.

8. Start lowering using the control unit (push-button panel) until reaching the desired immersion level without posing any risk to the user.
9. Unfasten the safety belt so that the user can leave the seat.

IMPORTANT: during descent, the user must not place their weight on the footrest, even when submerged.

10. Return the seat to the initial position: outside the pool, ready to receive another user. This prevents the lift from becoming an obstacle for swimmers. It is recommended to press the emergency stop on the control box and lock the rotation of the Pool Lift to avoid unintended movements by anyone in the pool area.

To exit the pool, follow the same steps in reverse, paying attention to the same precautions and warnings.

Movement of the S-3800 lift:

- Rotation of the lift is carried out manually with the assistance of another person.
- Lifting and lowering of the lift is carried out using the control unit (push-button panel) or the buttons on the control box.



Correct use of the METALU S-3800/1 Pool Lift with automatic rotation:

The process begins with the user entering the pool:

1. Access to the seat can be made from whichever side is most convenient and easiest for the user.
2. Release the emergency stop on the control box and take the control unit (push-button panel).

IMPORTANT: If the lift is to be used autonomously by a single person, the control cable must be passed through the **safety attachment** located near the seat.

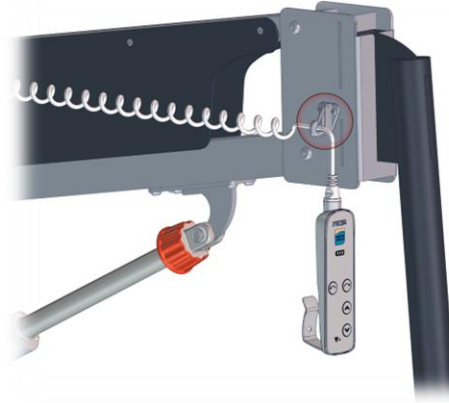

3. Sit on the seat, place your feet on the footrest and fasten the safety belt.
4. Press the control unit (push-button panel) to raise the seat until the footrest clears the height of the pool edge (the control operates both the lifting/lowering actuator and the rotation motor).

IMPORTANT: The control unit (push-button panel) has a 2-second delay for rotation.

5. Once raised, press the rotation button on the control unit (push-button panel) until the lift is positioned over the pool water surface.

IMPORTANT: It must be verified that there are no swimmers in the water who could be under the seat of the Pool Lift at any point during its movement. The landing area must be monitored to prevent accidental impact.

6. Start lowering until reaching the desired immersion level without posing any risk to the user.
7. Unfasten the safety belt so that the user can leave the seat.
8. **IMPORTANT:** during descent, the user must not place their weight on the footrest, even when submerged.
9. Raise the seat and rotate it out of the pool. This prevents the lift and its accessories from posing a risk to swimmers. It is recommended that the control unit (push-button panel) is left in an accessible position for the next use of the Pool Lift.

To exit the pool, follow the same steps in reverse, paying attention to the same precautions and warnings.

Movement of the S-3800/1 lift:

- Both rotation and lifting/lowering of the lift are carried out from the control unit (push-button panel) in a fully autonomous manner. The control box also includes buttons to perform any of the described movements.



- The S-3800/1 model allows switching to **manual rotation** mode in a very simple way:

1. Remove the two positioners from the motor from their "Automatic" position.

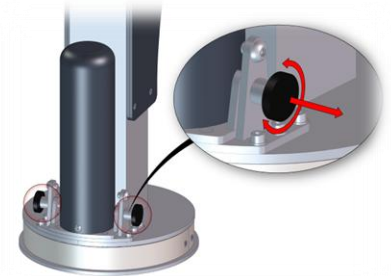

2. Raise the rotation motor to its upper stop (screws).

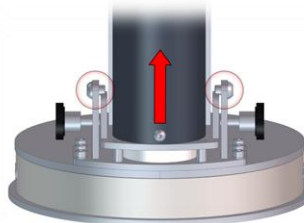

3. Reposition the two positioners, this time in the "Manual" position, allowing the lift to be rotated manually.

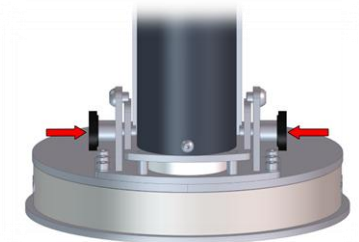

10 basic rules

1 METALU equipment must be installed in accordance with the manufacturer's instructions, making any necessary enquiries. The installer must test the equipment once installation has been completed and ensure that everything is functioning correctly.

2 In accordance with Article 12 of Law 11/1997 on Packaging, the final holder is responsible for the packaging. Reuse it whenever possible and dispose of the remainder at appropriate recycling facilities.
Protecting the environment is everyone's responsibility.



3 METALU equipment must only be used by facility managers and authorised users.

4 Facility managers must be familiar with the equipment after having read the instructions. If, after reading them, there are any doubts, the manufacturer must be contacted using the addresses provided therein.

5 Facility managers must inform users about the correct operation of the equipment.

6 Before operating the lift, ensure that the operating radius is clear. While the lift is in operation, do not place hands or any objects in its moving parts.



7 External cleaning is a mandatory condition for warranty validity. Follow the cleaning instructions supplied with the lift.



8 In accordance with the Low Voltage Electrical Regulations (REBT), ITC-BT-31, the machine must be connected to the equipotential bonding conductor that the swimming pool is required to have.

9 The installer must be aware of and take into account the regulations of the relevant autonomous community when carrying out the installation.

10 If the holder of this document is not the final customer, it must be passed on to them.

MANUFACTURAS METÁLICAS LUISIANERAS, S.L.

Battery-powered pool lift METALU S-3800 y S-3800/1

Manual and certificates

Address: Polígono Industrial Los Motillos, C/ Madrid No. 11, units A, C, D, G, H. 41430.

City: La Luisiana (Sevilla) – España.

Tax ID: B – 41834508

Main telephone: +34 955 907 784

Website: www.ascensoracuatico.com

Email: info@ascensoracuatico.com

Technical support contacts:

- Telephone: +34 613 165 661
- Email: soporte1@ascensoracuatico.com



Other documentation available:



Installation and assembly



Exploded view and
troubleshooting